

BLÜCHER® Drain Design

Douches Contemporaines

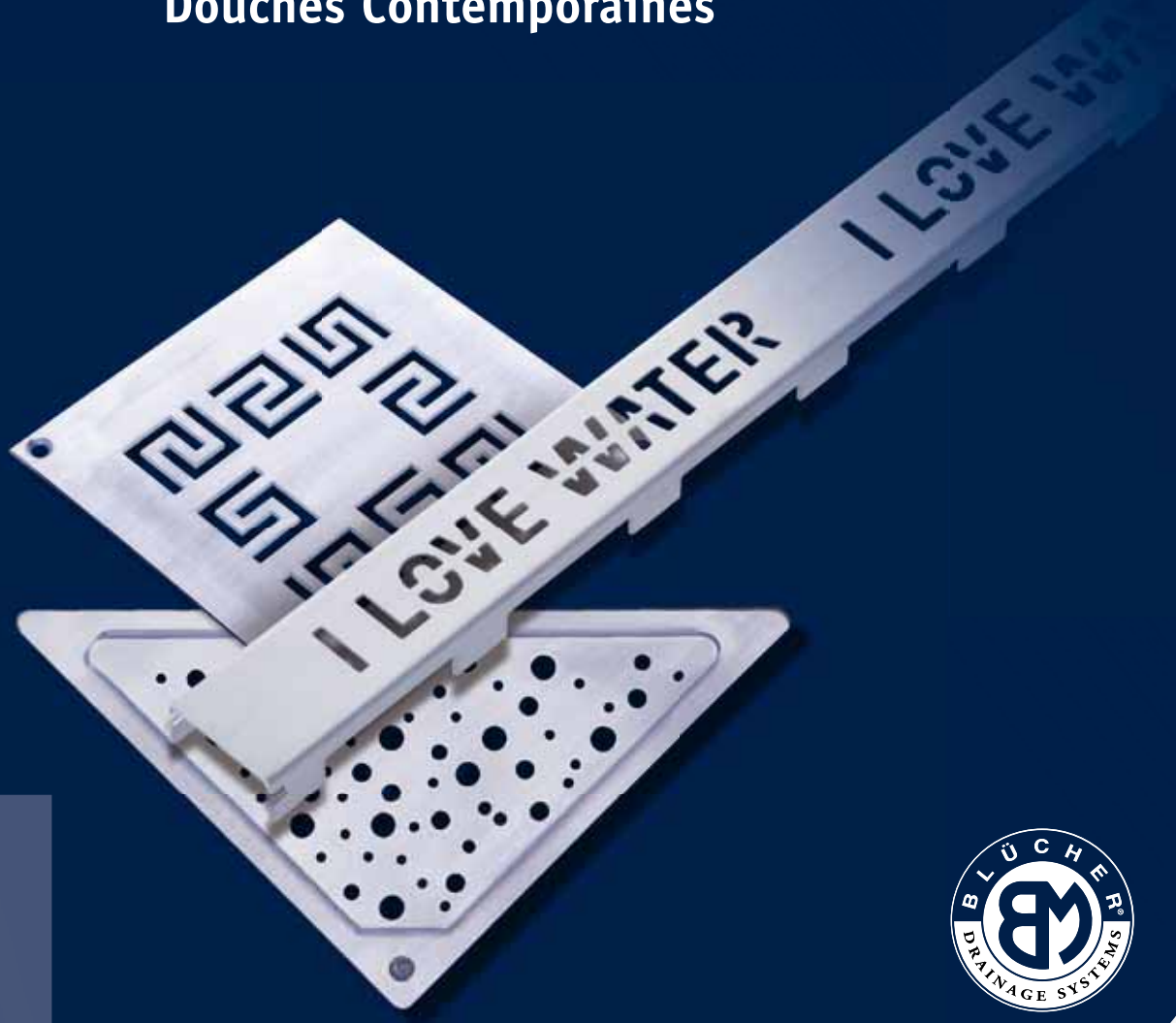

BLÜCHER®

K E E P I N G U P T H E F L O W

SYSTÈME D'ÉVACUATION EN ACIER INOXYDABLE

ATHENS



ATHENS Classique
Le design ATHENS ravive
notre mémoire sur la grande
épopée des temps anciens
chargés d'histoire.

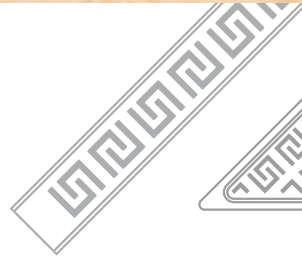
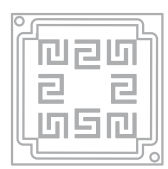

COPENHAGEN



COPENHAGEN Minimaliste
Le design COPENHAGEN
est la signature élégante
et minimaliste de ceux qui
portent attention au
moindre détail.

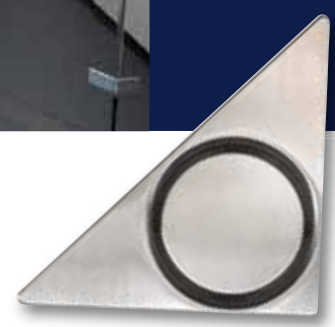
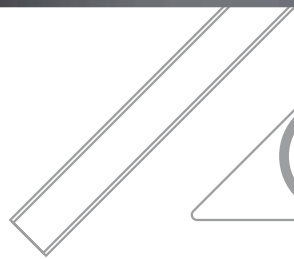
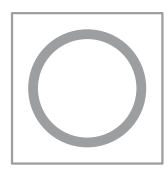

OSLO



OSLO Moderne

Heureux mélange d'authentique et de contemporain OSLO nous offre la fraîcheur au travers d'un bouquet de gouttes d'eau.

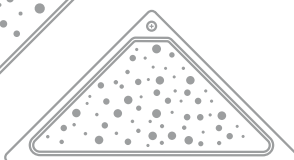
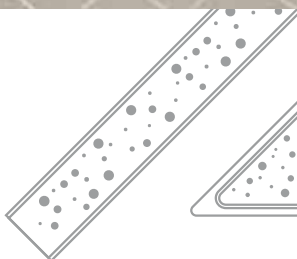
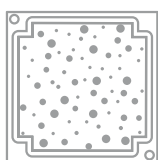
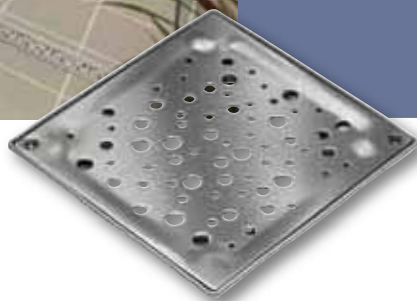

VIENNA



VIENNA Pratique

La composition VIENNA met l'accent sur la fonctionnalité tout en faisant lien avec la tradition.

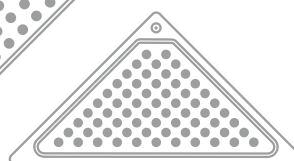
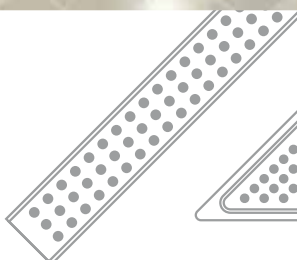
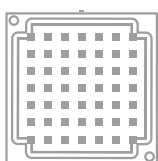

WaterLine caniveau de douche

Solutions pour les situations de reprise d'étanchéité renforcée se connecter sur www.blucher.com

Contact avec 3 parois Type n° 171

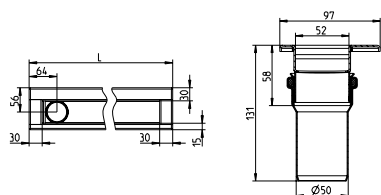

Référence	Longueur
171.070.056.20	700
171.080.056.20	800
171.090.056.20	900
171.100.056.20	1000

Contact avec 1 paroi Type n° 174

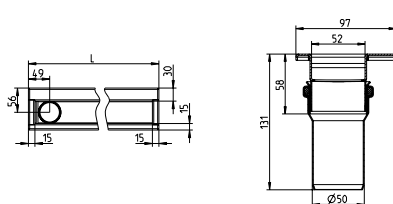

Référence	Longueur
174.030.056.20	300
174.070.056.20	700
174.080.056.20	800
174.090.056.20	900
174.100.056.20	1000

Placement libre Type n° 175

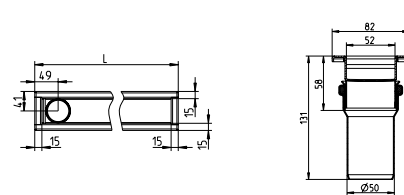

Référence	Longueur
175.070.056.20	700
175.080.056.20	800
175.090.056.20	900
175.100.056.20	1000

Grilles et évacuations vendues séparément.

WaterLine spécial sol souple

Placement libre Type n° 275

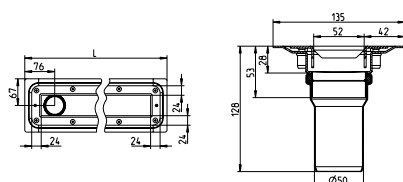

Référence	Longueur
275.070.056.20	700
275.080.056.20	800
275.090.056.20	900
275.100.056.20	1000

Grilles et évacuations vendues séparément.

Caniveaux sur mesure

Des longueurs intermédiaires ou autres peuvent être réalisées à la demande.
Nous contacter à mail@blucher.fr

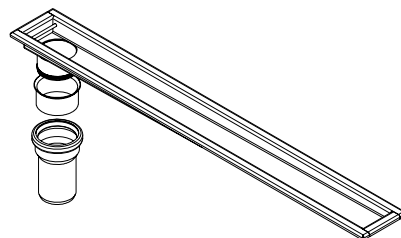

Avantages

- Pose à l'endroit de votre choix
- Siphon démontable
- Simple et moderne
- Choix de 6 styles de grille
- Installation aisée
- Bordure asymétrique pour recevoir la mosaïque

Accessoires pour caniveaux WaterLine

Siphonide

Référence	Garde d'eau	Débit
510.000.075	50 mm	0,8 l/s

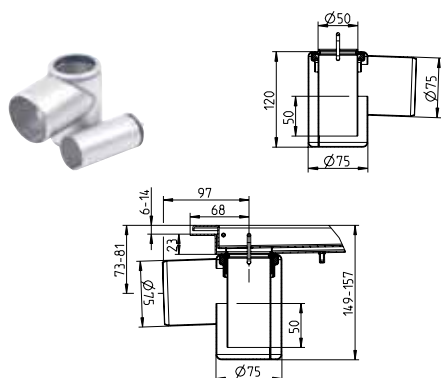

Siphonide en place

Note :

Le boîtier siphonide doit être commandé en même temps que le caniveau pour être installé lors de la pose.

Etanchéité. Clapet anti odeur

Référence	Débit
326.WLA.502	0,8 l/s

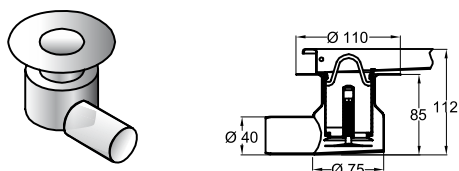

Avaloir sortie horizontale

Référence	Ø d'évacuation
620.300.028	Ø 40

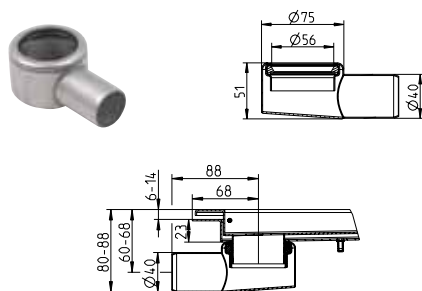

Grilles

Référence	Style	Longueur
697.003.030	LINE VIENNA	300
697.003.070	LINE VIENNA	700
697.003.080	LINE VIENNA	800
697.003.090	LINE VIENNA	900
697.003.100	LINE VIENNA	1000
697.004.030	LINE COPENHAGEN	300
697.004.070	LINE COPENHAGEN	700
697.004.080	LINE COPENHAGEN	800
697.004.090	LINE COPENHAGEN	900
697.004.100	LINE COPENHAGEN	1000
697.005.030	LINE ATHENS	300
697.005.070	LINE ATHENS	700
697.005.080	LINE ATHENS	800
697.005.090	LINE ATHENS	900
697.005.100	LINE ATHENS	1000
697.006.030	LINE DETROIT	300
697.006.070	LINE DETROIT	700
697.006.080	LINE DETROIT	800
697.006.090	LINE DETROIT	900
697.006.100	LINE DETROIT	1000
697.007.030	LINE NEW YORK	300
697.007.070	LINE NEW YORK	700
697.007.080	LINE NEW YORK	800
697.007.090	LINE NEW YORK	900
697.007.100	LINE NEW YORK	1000
697.008.030	LINE OSLO	300
697.008.070	LINE OSLO	700
697.008.080	LINE OSLO	800
697.008.090	LINE OSLO	900
697.008.100	LINE OSLO	1000
697.104.070	LINE COPENHAGEN VINYL	700
697.104.080	LINE COPENHAGEN VINYL	800
697.104.090	LINE COPENHAGEN VINYL	900
697.104.100	LINE COPENHAGEN VINYL	1000

Siphon de sol Triangulaire

Solutions pour les situations de reprise d'étanchéité renforcée se connecter sur www.blucher.com

Installation en angle



Contact avec une paroi



Bordure asymétrique pour recevoir la mosaïque.

Débit : 0,8 l/s

Garde d'eau : 50 mm

Conforme NF 1253

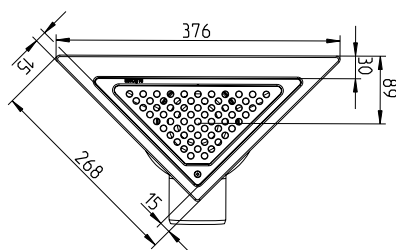
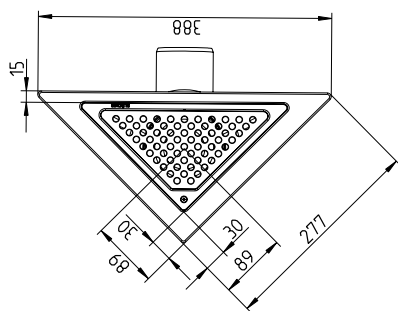

Siphon évacuation horizontale.

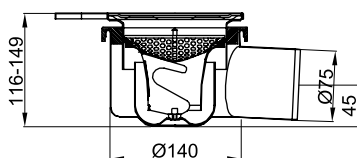

Nous consulter pour référence en \varnothing 50 mm

Référence	Pose
110.360.075	Angle
110.370.075	Contact avec 1 paroi

Siphon évacuation verticale.

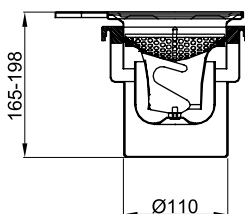

Référence	Pose
150.360.110	Angle
150.370.110	Contact avec 1 paroi

Grilles optionelles

Les siphons TRIO sont livrés avec la grille VIENNA en version de base. Les autres modèles sont à commander séparément.

Précisez le nom de la grille choisie à la commande.



OSLO



ATHENS



DETROIT



NEW YORK



COPENHAGEN

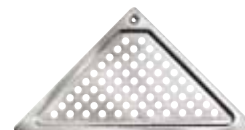

VIENNA

BLÜCHER®

Brochures

BLÜCHER®
Catalogue Général. Pièces de val en acier inoxydable.



BLÜCHER KEEPING UP THE FLOW

STAINLESS STEEL ORDNANCE SYSTEM

BLÜCHER Catalogue Général

BLÜCHER Compact
Idéal pour les applications résidentielles, tertiaires et industrielles.



BLÜCHER KEEPING UP THE FLOW

SYSTÈME D'ORDONNANCE EN ACIER INOXYDABLE

BLÜCHER® Compact

BLÜCHER EuroPipe
Tubes et raccords embrochantes en inox



BLÜCHER KEEPING UP THE FLOW

SYSTÈME D'ORDONNANCE EN ACIER INOXYDABLE

BLÜCHER® EuroPipe

BLÜCHER
Cuisine Collective



BLÜCHER KEEPING UP THE FLOW

SYSTÈME D'ORDONNANCE EN ACIER INOXYDABLE

BLÜCHER® Cuisine Collective

BLÜCHER®

BLÜCHER® est le fabricant spécialisé dans la production de systèmes, en acier inoxydable, dédiés à la collecte des effluents. Nos produits répondent aux spécifications requises par l'industrie, le tertiaire et la construction navale.

BLÜCHER® EuroPipe

BLÜCHER® Channel

BLÜCHER® Drain



BLÜCHER

Z.I. Petite Montagne Sud
1 allée du Dauphiné
C.E. 1816
91018 Evry Cedex
Tel.: 01 60 86 30 15
Fax : 01 60 86 06 13
E-mail : mail@blucher.fr
www.blucher.fr



KEEPING UP THE FLOW